

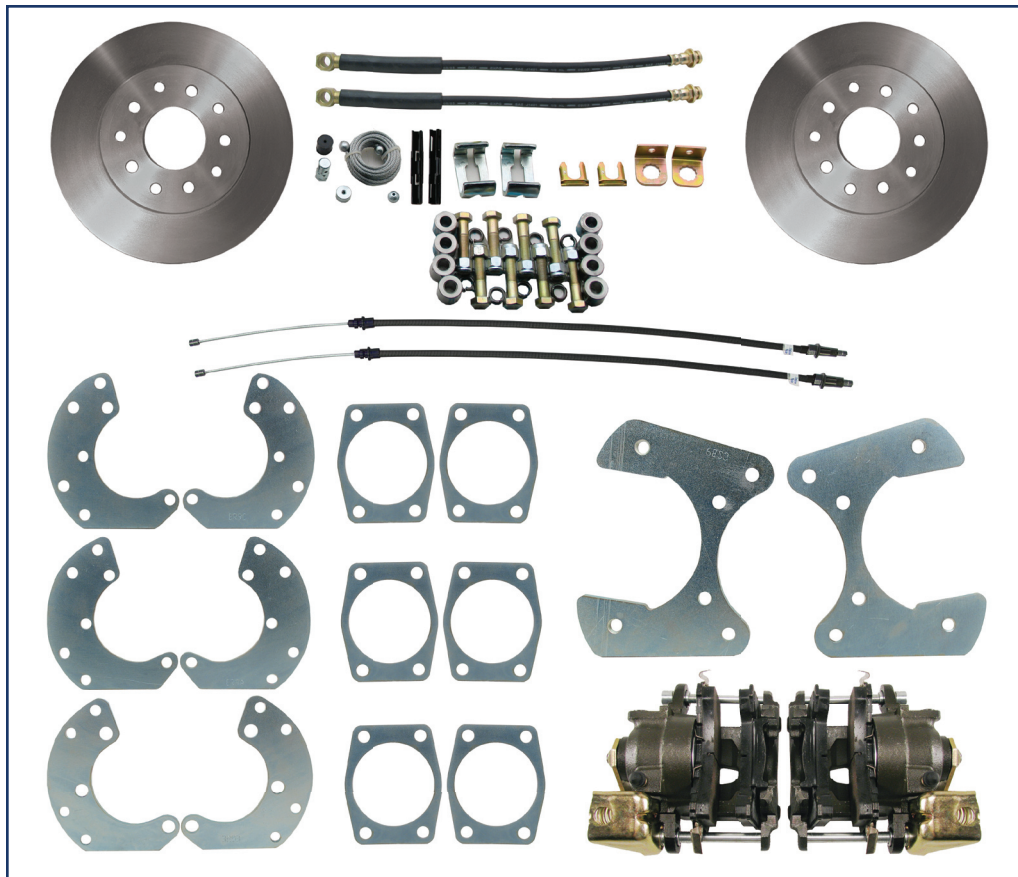

DBK9

FORD 9" REAR END DISC BRAKE CONVERSION KIT

FITS THE THREE MOST POPULAR REAR ENDS (3-3/8" X 2", 3-1/2" X 2-3/8", 3-9/16" X 2").



NOTE: ALSO AVAILABLE IN HIGH PERFORMANCE KIT WITH STAINLESS STEEL BRAIDED HOSES & CROSS-DRILLED & SLOTTED ROTORS

INSTALLATION INSTRUCTIONS

NOTE: ALWAYS REFER TO THE VEHICLE OWNER'S MANUAL FOR CORRECT TORQUE SPECIFICATIONS WHEN INSTALLING KIT.

WARNING Proper operation of your brakes is essential for your safety and the safety of others. Any brake service should be performed **ONLY** by persons experienced in the installation and proper operation of brake systems. It is the responsibility of the person installing any brake component or kit to determine the suitability of the component or kit for the particular application. After installation, and before operating your vehicle, be sure to test the function of the brakes under controlled conditions. **DO NOT DRIVE WITH UNTESTED BRAKES!**

IMPORTANT Take time to read all the literature that came with this kit. Before beginning installation check the provided list of parts against what you received to ensure that all parts are present. While this kit was designed to make the process of changing brake parts as simple as possible, **NOTE: WITH SOME KITS IT MAY BE NECESSARY TO MAKE MINOR CHANGES TO YOUR CAR! READ ALL WARRANTY DISCLAIMERS AND RETURN POLICIES INCLUDED IN THIS KIT PRIOR TO INSTALLATION!**

NOTE Always utilize safety restraints when operating the vehicle. The installation of disc brakes will require the use of 15" wheels. Any attempt to install disc brake with a 14" wheel will be the customer's responsibility.

NOTE This kit is an aftermarket solution. It is not intended to be a direct installation or OEM replacement. Due to changes in production in certain years, your car may require modifications beyond these instructions for this kit to install properly.

INSTALLATION INSTRUCTIONS

PARTS INCLUDED WITH THIS KIT:		
PART #	DESCRIPTION	QUANTITY
BR9ASET	contains (2) BR9A bracket and (2) FL9A	1 bag
BR9BSET	contains (2) BR9B bracket and (2) FL9B	1 bag
BR9CSET	contains (2) BR9C bracket and (2) FL9C	1 bag
CSB9	Caliper Bracket	2
HWK9	Hardware Kit	1 bag
HSDBK-10mm	Brake hose	2
EBK9	Emergency brake kit	1 bag
BHC9	2 brake hose mounts and 2 clips	1 bag
NR172/NR173	Left & Right brake caliper	1 box
5560 Rotors	Rotors	2
PERFORMANCE UPGRADE PARTS:		
5560-10LX/RX	Cross Drilled & Slotted Rotors	2
HSDBK-SS-10mm	Stainless Steel Braided Hoses	2
NOT INCLUDED PARTS REQUIRED FOR PROPER OPERATION:		
PV4	Disc/Disc Proportioning Valve	1
	1 1/8" Bore Master Cylinder	1
We also strongly suggest replacing the Axle Shaft Seals during installation of this kit.		
OPTIONAL PARTS (NOT INCLUDED WITH BASIC KIT, AVAILABLE FOR SEPARATE PURCHASE):		
	Power Booster	
	Master Cylinder	
	Proportioning Valve Kit	
	Vacuum Hose & Fittings	

PREPARING YOUR VEHICLE TO INSTALL YOUR BRAKE SYSTEM UPGRADE

1. Rack the vehicle.
2. If you don't have a rack, then you must take extra safety precautions.
3. Choose a firmly packed and level ground to jack up the vehicle.
4. Chock the front wheels.
5. Jack the vehicle up and support it with jack stands and secure the pins.
6. Put the transmission in park if automatic, reverse if manual transmission.
7. The wheels should be allowed to free hang to relieve tension on the springs.

IMPORTANT NEVER rely on jacks to support a vehicle! Always test the steadiness of your stands that are supporting the vehicle before attempting to work on a raised vehicle!

COMPONENTS TO INSPECT, REPLACE OR UPGRADE DURING INSTALLATION OF DISC CONVERSION KITS

Shocks and hardware	Proportioning Valve	Proportioning valves
Brake lines	Stainless steel brake lines	Stainless steel hardware

SUGGESTIONS:

- » Take the time to identify any suspect parts that are not included in this kit.
- » Make upgrades such as converting to polyurethane bushings, performance shocks, Coil Over Springs, etc.
- » Plan any Installation (s) of replacement parts during the various stages of the drum to disc conversion process.
- » Check for interference with the exhaust system before installation.
- » Check for proper master cylinder bore size

Slide Hammer Tool	Drum brake tool	Flare wrench set	Wheel chocks
3/8" ratchet drive set	3/8" Allen wrench or socket	Jack stands	Brake spring pliers
Box end wrench set	Differential Fluid	Tire iron	Brake bleeder wrench
Pliers	Screwdriver	Snips	
Brake Fluid	Line bending tool 555-80086	Disc brake quiet	Wheel bearing grease
Caliper slide grease	Brake cleaner	Hand cleaner	

INSTRUCTIONS

NOTE: THE REAR AXLES MUST BE REMOVED TO INSTALL THIS KIT!

1. Prior to disassembly spray the nuts and bolts that will be removed with a penetrant.
2. Remove the rear tires.
3. Disconnect the drum brake hoses from the hard line using the appropriate flare wrenches.
4. Remove the stock Ford drums, brakes and the backing plates from the housing. To do this, you will first need to remove the "T" bolts that hold the backing plates and the axles to the housing.



Slide Hammer w/ Axle Flange Adaptor

5. Now pull the rear axles out of the rear end housing by using an axle puller. This will ensure the no damage is done to the axle flange or bearings.
6. Now you can remove the drum backing plate and disconnect the emergency brake.
7. Clean the rotors using brake cleaner first, then with soap and water. Dry with a clean towel.
8. Check to make sure that the axle flange is 6 1/8" in diameter or smaller. (Trial fit the rotor to the axle flange.) This will ensure that the rotor will mount flush to the axle flange. (If the axle flange is larger than 6 1/8", you will need to machine it down to the proper size.) If you have aftermarket axles consult the manufacturer before machining them.
9. Clean the axle housing flanges and where the axle bearing seats.
10. Now you will need to determine which set of spacers and brackets you will need for your car. Each set has been individually bagged for ease of identification. The easiest way to identify which set you will use is to check the holes in the spacer plate (in bags labeled A,B, and C) to see if they align with the holes in **your** axle housing.

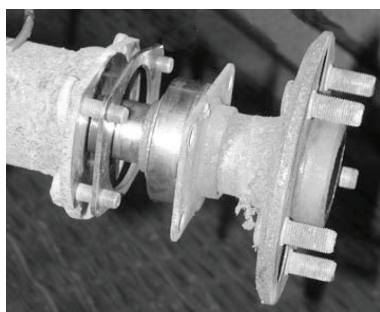

Installation of Spacer Plate.

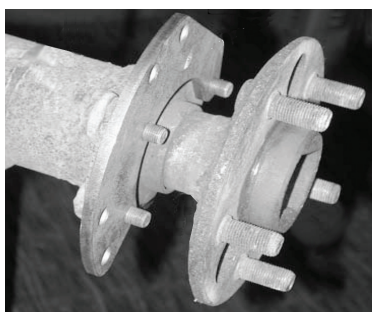

Installation of small bracket.

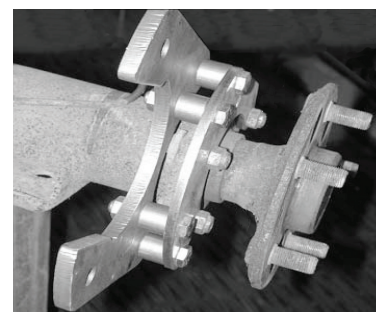

Installation of caliper bracket.

11. Once you have determined the proper bracket set, install the axle spacer plate followed by the axle. (The spacer plate will take the place of the backing plate.)
12. Install the primary bracket so that the calipers will be mounted up and toward the rear of the car.
13. Now reinstall and tighten the bearing retainer nuts.
14. Take the supplied bolts, and install those on the primary bracket. Use the spacers, that are also provided, and install those onto the bolts. (See Figure 1)
15. Bolt the secondary bracket to the primary bracket and tighten the nylock nuts.

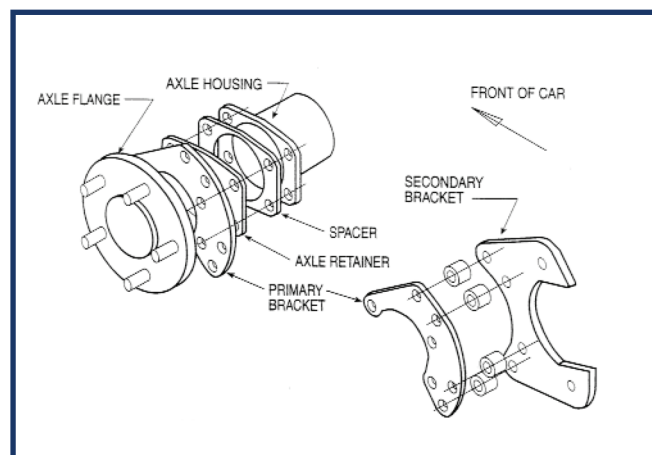

Figure 1

16. **IMPORTANT: Check to be sure the axle retaining "T" bolt heads clear the edge of the secondary bracket! If the "T" bolts interferes with the secondary bracket, it will be necessary to trim the bolt head to allow it to seat properly.**
17. Install the new rotor onto the axle flange. (Note: Use two or three wheel nuts to hold the rotor in place so you can complete the installation. Only hand tighten the wheel nuts so that you will not damage or warp the rotor.) Now rotate the rotor and check that the rotor runs true. You also want to be sure that nothing is interfering with the rotation. To be sure that the rotor is flush to the axle flange and is all the way over the axle center pilot, insert some strips of paper between the back of the rotor and the axle flange. If you cannot pull the paper out easily, then the rotor is all the way on.
18. The installation of the rear caliper has three steps:
 - A. Physically installing the caliper.
 - B. Physically setting up the emergency brake.
 - C. Emergency brake adjustment.

19. With the rotor and caliper bracket installed, locate the two metal slider sleeves that the mounting bolts go through (Fig. 2).



Fig. 2

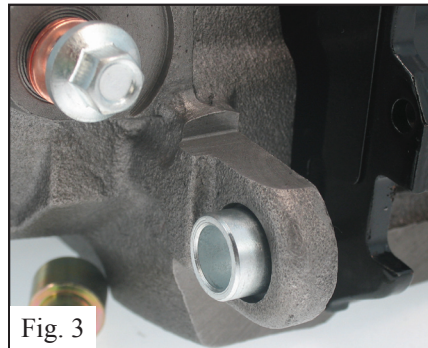

Fig. 3

20. With your thumbs, press the slider sleeves flush against their tabs to allow the caliper to be installed into the caliper bracket smoothly (Fig. 3). Prior to inserting the caliper into the bracket, you need to make sure that the pads are installed correctly.
21. The inboard pad has a special clip (Fig. 4) that snaps over the caliper piston and rests in a groove on the piston. The pad has notches into which the tabs of the clips fit (Fig. 5).

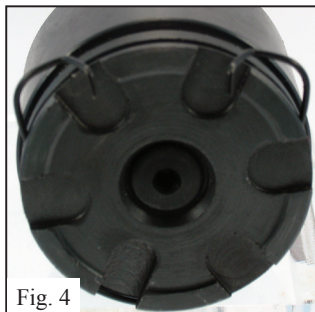

Fig. 4



Fig. 5

22. Now insert the caliper, with the pads installed, into the caliper bracket. The bleeder screws and springs should be at the top with the caliper on the rear of the axle.
23. It may be necessary to retract the caliper piston to allow the brake pads to clear the rotor.
24. To retract the piston, remove the spring on the emergency brake. Be sure to note the position of the spring. Next remove the nut and its' lever. Be sure to note the position of the lever.
25. Move the piston in or out as needed by turning the shaft with the wrench positioned on the integrated hex nut. You may also use the lever to adjust piston depth.
26. Reinstall the bracket, spring, and pads. Install the caliper into the caliper bracket, and press the slider sleeves up against the caliper bracket and tighten down the 2 mounting bolts using an Allen wrench. If needed, install the bracket shims between the axle and the caliper bracket in order to center the caliper over the rotor.
27. Test spin the rotor, and once it is centered, tighten down the bracket.
28. Proceed to setting the emergency brake.
29. If you have not already done so, remove the original drum brake cables from the vehicle.
30. You will be using the front and middle sections of the original drum cable setup.
31. Next feed the end of the new cable through the spring and locate, but do not install the cable into the notch on the lever yet.
32. Now take the clip provided with the kit and stake it over the emergency brake cable to steady the cable against the caliper. Save the old emergency brake clip so you can check the new brake clips for the proper size.
33. With the system physically assembled, proceed to the adjustment of the e brake setup.
34. Attaching the flexible brake hose to the caliper and then to the hard line. Now attach the E-brake cable to the caliper. The parking brake cables are supplied to bring you to a central point, It is the customers responsibility to tie the cables into the system!
35. Bleed the brakes and test for a full pedal. If the back wheels skid before the front you should install a

proportional valve to reduce the pressure to the rear brakes.

REAR CALIPER ADJUSTMENT

When installing rear disc brakes with calipers that have an internal parking brake you must adjust or set the calipers when installing. Failure to do so will prevent you from getting a firm pedal and you will have no rear brake function. Only do this adjustment with the caliper and rotor installed on the vehicle. You must set the parking brake every time you park to keep the calipers adjusted.

INITIAL ADJUSTMENT

1. Remove the spring.
2. Crank the lever or turn the retention nut to actuate the lever forward.
3. After cranking the lever forward as far as it will go, rotate it back the other way until you hit the stop. You may need to use a long screwdriver to lever the lever back into place.
4. The rear caliper should now be correctly adjusted.
5. Re-install spring

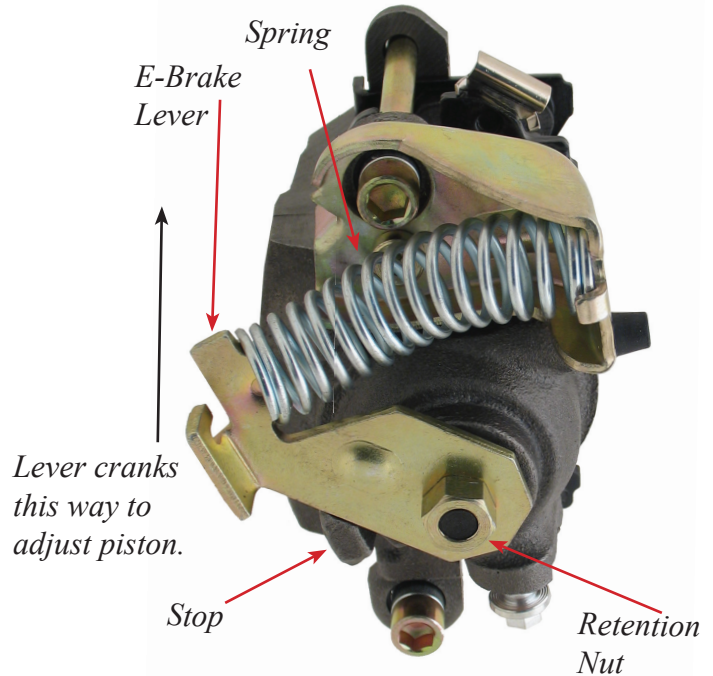

Important: You must use the parking brake mechanism on a regular basis to set the self adjusting calipers. Failure to use the rear parking brake will result in rear brake loss!

BOOSTER & MASTER CYLINDER INSTALLATION (IF PURCHASED WITH KIT)

1. Disconnect the old master cylinder lines (Remember, if operating around painted surfaces, avoid brake fluid to paint contact). Remove any valves that are installed in the drum system and discard. If the vehicle has a pressure differential switch, it must also be removed. Remove the old master cylinder.
2. When changing from a manual brake system to a power system, the clevis assembly that attaches the push rod to the brake pedal must be removed and lowered one inch. If two holes are in the pedal use the lower hole for the power booster rod attachment. If only one hole exists from the manual system a second hole must be drilled one inch lower. Remove the clip and pin that attaches the clevis to the brake pedal and retain them. If the lower hole does not already exist, one must be drilled. Screw the clevis assembly onto the new push rod on the booster about 1/2".
3. Mount the booster to the fire-wall with the existing studs or bolts. Place the clevis assembly into the lower hole in the pedal and install the pin and clip.
4. Install the proper fitting into the intake manifold for vacuum. Connect the vacuum hose from the engine to the power booster. **YOU WILL NEED AT LEAST 18" VACUUM TO OPERATE A BOOSTER.**
5. Bench bleed the master cylinder with the supplied bleeder kit.
6. Install the master cylinder onto the booster.
7. Mount the combination valve to supplied bracket and attach the bracket and lines as shown in fig. 4.
8. You will now need to run two lines from the supplied combination valve to the frame. Tie the lines into the existing front and rear lines with brake line couplers. You may run two separate lines from the combination valve to each front wheel or you may plug one outlet to the front, run one line and then split it to each front wheel.

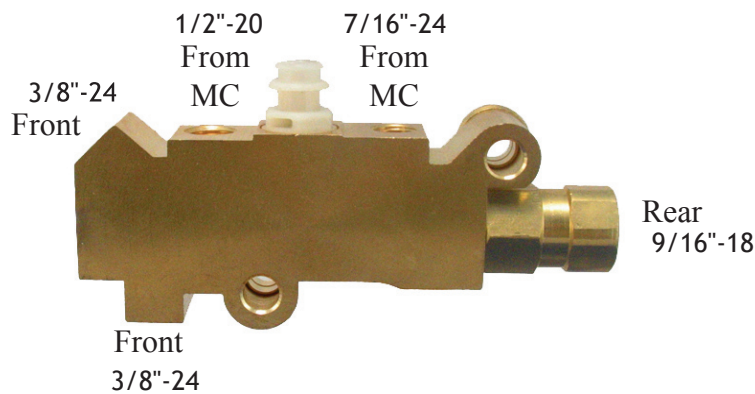

INSTALL LINES AS SHOWN IN DIAGRAM:

The most common proportioning valve plumbing is shown. An alternative plumbing method is to plug off the top front line and have the bottom front line go to a "T" fitting. From the "T" fitting, the front lines are then split off to the left and right calipers.

TESTING THE PROPORTIONING VALVE FOR PROPER OPERATION:

1. Use a test light by attaching a clip to a positive contact on the vehicle and touch the point of the tester to the electrical connection of the combination valve. If the light does not come on, the valve system is operation correctly and no further testing is required.
2. If the light does come on, this indicates that the pressure differential valve is stuck in the front or rear position.
3. Bleed the brake system to determine if the front or rear lines are blocked off. Set up one front wheel and one rear wheel for bleeding at the same time. Crack both bleeder screws and gently pump the pedal a few times. The blocked side will trickle fluid out when the bleeder screw is cracked and the pedal pressed. An unblocked line will squirt fluid out the bleeder.
4. The lines that are clear must be left open and the blocked lines should have the bleeder screws tight to cause pressure to build up on that side. Be sure to use the standard bleeding procedures to prevent air from entering the system.
5. Slowly press the pedal with steady pressure a number of times until the light goes out; this will center the differential valve. You may also hear a pop come from the proportioning valve. This is the metering valve returning to its equalized position. When the light goes out, close the bleeder screw.

WHAT TO DO IF YOU SUSPECT YOUR BOOSTER IS NOT WORKING

It is rare that one of our kits will contain a defective power booster but if you suspect that your booster is not functioning correctly perform the following tests:

BASIC TEST

1. With the engine off depress and release the brake pedal several times to eliminate vacuum from the power section.
2. Depress the pedal and hold down with light pressure, 15 to 25 pounds.
3. Start engine.
4. If the power unit is operating the pedal will drop slightly. Less pressure will be needed to hold the pedal down.

IF BOOSTER IS NOT OPERATING (GIVING A VERY HARD PEDAL)

1. Disconnect the vacuum hose from the booster check valve and check the vacuum level at this point with the engine running with a vacuum gauge. You should have at least 18" vacuum to the booster. Anything lower will begin to give a hard pedal. If the vacuum level is below 18" you may be able to tune the engine and bring the vacuum level up to that level. If the vacuum level is around 16" the addition of a vacuum reserve canister will improve the braking. If the vacuum level is below 16" you will need to add an electric vacuum assist pump to supplement the engine vacuum.

2. If the vacuum level at the check valve is 18" check that the booster check valve is working. Disconnect the vacuum hose at the check valve and attach a piece of tubing. Blow into the valve. If air passes through the valve is defective and must be replaced. Also look into the hose attachment neck on the check valve and be sure there is no obstruction inside the valve.
3. Check your booster for a vacuum leak. With everything hooked up run the engine at moderate speed. Release the accelerator and turn the engine off. Wait 90 seconds and apply the brakes. If the brake applications are power assisted there is no leak. If there is no power assist the booster is defective and must be replaced.

IF THE BOOSTER IS OPERATING BUT YOU STILL HAVE A HARD PEDAL

1. Your combination valve may have tripped shutting off fluid flow to the front or rear brakes. This condition will produce a very hard pedal. Check that fluid passes through the valve to both the front and rear by cracking a bleeder screw and observing a good flow of fluid. If one half of the system does not have flow, re-center the valve.
2. You may have frozen rear wheel cylinders or frozen caliper pistons. If these components freeze you can get a very hard pedal.
3. Your pedal ratio may be too low. Check your pedal ratio. The pedal ratio must be in between 4:1 to 5:1. Some of the older cars that had power brakes used a ratio of almost 1:1. If you add a vacuum booster to this type of car you will have a very hard pedal. Typically we are talking about late 50's cars. Adjust ratio as necessary.
4. Your booster may be undersized for the weight of the vehicle or the bore size of the master. If you try to use a small diameter booster such as a 7" street rod booster for a heavy car you will get a very hard pedal. Compounding the problem is an attempt to use a large bore master (1-1/4" or larger) on a small booster.

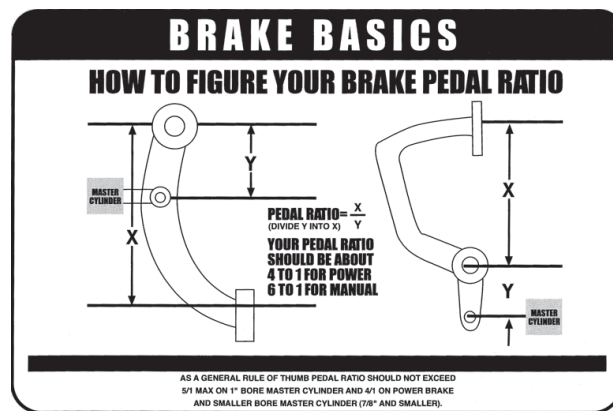

IF YOUR BRAKE PEDAL IS VERY SENSITIVE AND THE BRAKES GRAB

1. Your pedal ratio may be too high. Power brakes will require a 4:1 to 5:1 ratio. If your ratio is around 6:1 you are getting too much mechanical advantage making the brakes extremely sensitive. Adjust the ratio to correct level.
2. The booster may be too large for the weight of the vehicle. Lightweight vehicles with large boosters give you "touchy brakes". This effect may be dampened somewhat by going to a larger bore master.
3. Too large a booster for front drum brakes. Drum brakes do not require as much pressure as disc brakes (500 psi vs. 1,000 psi). If your booster is very large (11") and you have drum brakes you are over-boosted. Do a pressure test to determine what you have.
4. The booster has a cracked internal hub. When there is a crack in the phenolic hub inside the booster it will be either totally on or totally off. Any slight pressure to the pedal will cause the brakes to lock up. The booster must be replaced.

TEN REASONS FOR A POOR BRAKE PEDAL

CAUSE	REASON
Bleeder screws on calipers not on top.	The bleeder screws on calipers must be at the 12:00 position on the caliper to allow all the air to escape during bleeding. A very common mistake installers will make is to reverse the side the caliper goes on giving you a situation where the caliper bleeder screw is facing down. It's also common to use the wrong caliper on a bolt on disc kit giving a situation where the bleeder hole is shifted from the 12:00 position producing a pocket of air at the top of the caliper bore which can not be dislodged. Check your bleeder hole orientation.
A defective master cylinder which does not hold pressure.	If brake fluid bypasses a pressure seal on a master cylinder you will get a pedal that fades. To test for this obtain two inverted flare plugs at an auto parts store and plug both master cylinder outlets. Try your pedal. If the pedal is high and firm the master is good. If the pedal fades the master is bad. Replace master as necessary.
No residual pressure valve to rear drums.	Drum brakes require the use of a 10 Ib residual pressure valve in the line. This residual pressure counter balances the drum brake spring tension keeping the shoes close to the drums. This results in a higher firmer pedal. You can test this by clamping off the rear hose removing the rear drums from the system. Now test your pedal. If the pedal gets better you will need to splice a 10 Ib residual pressure valve into the rear line.
Hard line that loops up.	Hard brake line that loops up and then back down will tend to trap air. It doesn't take much air to cause problems so check your lines carefully.
Incorrect master cylinder.	If the bore size of the master cylinder is too small for the fluid requirements of the system you will get a very poor pedal. This will happen most frequently with four piston calipers and with four wheel disc brakes. The only solution for this is to install a larger bore master cylinder or a true four wheel disc master.
Incorrectly bled or adjusted rear calipers.	Rear calipers that have an internal parking brake with a lever can be troublesome. These calipers must be adjusted so that the piston is moved out and the pads are close to the rotor. If this initial adjustment is not made the pistons will travel outward during activation but no squeezing of the rotor will occur. This can be checked by clamping off the rear hoses and checking if the pedal gets better. Adjust as necessary.
Incorrect booster pin length.	The booster pin that pushes on the master cylinder must almost be touching the master cylinder piston face. A gap larger than 1/32" will begin to introduce a spongy pedal. Adjust as necessary.
Silicone brake fluid.	While silicone fluid is great because it does not attack paint it also aerates very easily and can give a spongy pedal.
Rear wheel cylinders too large.	Rear drum wheel cylinders that are too large will give a poor pedal. Check as in step six above.
Loose front wheel bearings.	Loose front wheel bearings will cause rotor wobble. This will cause the caliper pistons to retract too far into the caliper giving a spongy pedal every time you hit the brakes. Check and adjust as necessary.

UNIVERSAL FRONT DISC BRAKE CHECKLIST

	Spindle properly secured to ball joints and tie rods with castle nut and cotter pin.
	All mounting bolts properly tightened.
	Wheel bearings properly packed with grease.
	Inner bearing must be installed before grease seal.
	Rotor I bearings slide onto spindle with ease.
	Washer, castle nut properly torqued and cotter pin installed.
	Calipers installed and properly torqued.
	Spin rotor and check for any interference. (If any interference is found, resolve problem before driving vehicle.)
	Flex lines are properly installed with no interference.
	Power booster (if applicable) installed properly.
	Master cylinder bench bled according to the instructions.
	All brake lines are properly tightened and free of leaks.
	Turn wheels lock to lock and check for any interference.
	Place wheel onto vehicle and spin the wheel to make sure there is no interference between the brakes and wheel.

UNIVERSAL REAR DISC BRAKE CHECKLIST

	All bolts on base bracket properly tightened.
	All caliper mounting bolts properly tightened.
	Rotor slides onto axle with ease.
	No interference with rotor and any other parts (splash shield, brackets, etc.).
	Caliper is centered over the rotor (because of difference in axle lengths, you may have to shim caliper in or out).
	No interference with caliper and rotor.
	All brake lines are tight with no leaks.
	Parking brake is properly adjusted and not dragging, with vehicle on ground.
	Adjustable proportioning valve installed (if applicable).
	Distribution block modification made (if applicable).
	Brake system properly bled.

IMPORTANT WITH EVERY NEW SET OF ROTORS AND PADS, YOU SHOULD GIVE YOUR VEHICLE 200 - 250 MILES OF EASY DRIVING TO PROPERLY SEAT THE PADS TO THE ROTORS. DO NOT TAKE THE VEHICLE UP TO 60 MPH AND JAM ON THE BRAKES BEFORE THE FIRST 200 - 250 MILE BREAK IN PERIOD IS OVER, OR YOU WILL GLAZE THE PADS AND ROTORS.